

WIRING CODE IDENTIFICATION INFORMATION

WIRE CODE IDENTIFICATION

Each wire shown in the diagrams contains a code (Fig. 1) which identifies the main circuit, part of the main circuit, gauge of wire, and color. The color is shown as a two-letter code, which can be identified by referring to the Wire Color Code Chart (Fig. 2).

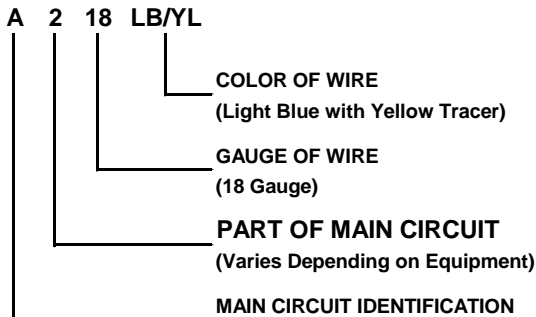

Figure 1 – Wire Color Code Identification

CIRCUIT IDENTIFICATION

All circuits in the diagrams use an alphanumeric code to identify the wire and its function (Fig. 3). To identify which circuit code applies to a system; refer to the Circuit Identification Code Chart. This chart shows the main circuits only and does not show the secondary codes that may apply to some models.

Base Wire Color Code Chart			
Color Code	Color	Color Code	Color
BK	BLACK	OR	ORANGE
BL	BLUE	PK	PINK
BR	BROWN	RD	RED
DB	DARK BLUE	TN	TAN
DG	DARK GREEN	VT	VIOLET
GY	GRAY	WT	WHITE
LB	LIGHT BLUE	YL	YELLOW
LG	LIGHT GREEN		

Figure 2 – Wire Color Code Charts

Tracer Wire Color Code Chart			
Color Code	Color	Color Code	Color
BR	BROWN	OR	ORANGE
DB	DARK BLUE	TN	TAN
DG	DARK GREEN	VT	VIOLET
GY	GRAY	WT	WHITE
LB	LIGHT BLUE	YL	YELLOW
LG	LIGHT GREEN		

CIRCUIT	FUNCTION
A	- Battery Feed
B	- Brake Controls
C	- Climate Controls, EBL, Heated Mirror, Windshield and Seat
D	- Diagnostic Circuits, Communications, Antennas
E	- Dimming Illumination Circuits
F	- Switched Ignition Feeds
G	- Gauges, Displays, Monitoring, Body Sensors, Resistive Mux'd Switches
H	- Open
I	- Not Used
J	- Open
K	- Power Train Control Module
L	- Exterior Lighting, Headlamp Leveling
M	- Interior and Courtesy Lighting
N	- Fuel Pump, Radiator Fan
O	- Not Used
P	- Power Option, Seats, Recliner, Lumbar, Mirrors, Door Locks
Q	- Power Options, Windows, Vents, Sunroof, Tops, Trunk, Liftgate, Sliding Doors
R	- Restraint Systems
S	- Suspension/Steering
T	- Starter, Transmission, Transaxle, Transfer Case
U	- Open
V	- Speed Control
W	- Washer, Wiper
X	- Sound Systems, Horn
Y	- Open
Z	- Grounds

Figure 3 – Circuit Identification



WIRING CODE IDENTIFICATION INFORMATION

CONNECTORS

Connectors shown in the diagrams are identified using the international standard arrows for male and female terminals (Fig. 4). A connector identifier is placed next to the arrows to indicate the connector number (Fig. 4). For viewing connector pin outs, with two terminals or greater, refer to section 8W-80. This section identifies the connector by number and provides terminal numbering, circuit identification, wire colors and functions.

All connectors are viewed from the terminal end unless otherwise specified. To find the connector location in the vehicle, refer to section 8W-90. This section uses the connector identification number from the wiring diagrams to provide a figure number reference.

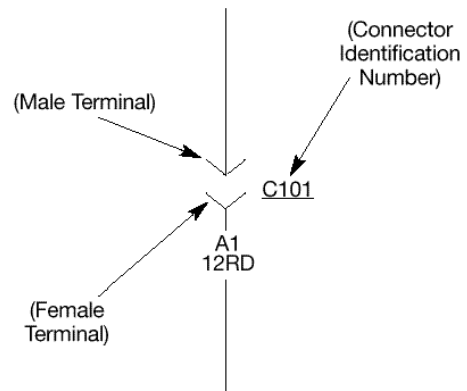

Figure 4 – Electrostatic Discharge Symbol

TAKE OUTS

The abbreviation T/O is used in the component location section to indicate a point in which the wiring harness branches out to a component.

ELECTROSTATIC DISCHARGE (ESD) SENSITIVE DEVICES

All ESD sensitive components are solid state and a symbol (Fig. 5) is used to indicate this. When handling any component with this symbol, comply with the following procedures to reduce the possibility of electrostatic charge buildup on the body and inadvertent discharge into the component. If it is not known whether the part is ESD sensitive, assume that it is.

- 1) Always touch a known ground before handling the part. This should be repeated while handling the part and more frequently after sliding across a seat, sitting down from a standing position or walking a distance.
- 2) Avoid touching electrical terminals of the part, unless instructed to do so by a written diagnostic procedure.
- 3) When using a voltmeter, be sure to connect the ground lead first.
- 4) Do not remove the part from its protective packing until it is time to install the part.
- 5) Before removing the part from its package, ground the package to a known good ground on the vehicle.

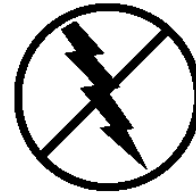

Figure 5 – Electrostatic Discharge Symbol

WIRING CODE IDENTIFICATION INFORMATION

WIRING GUIDELINES FOR 2013 RAM TRUCK AFTERMARKET/BODY BUILDERS

1. Introduction

These guidelines are intended as an aid in wiring design. It is not an all-inclusive list or a substitute for common sense. It is to be used as a supplement to existing good design practices and standards. Additional information is in the Referenced Publications section. Performing a Failure Mode and Effects Analysis (FMEA) on each completed wiring design is a good practice to confirm the integrity of the design. This document will be revised periodically, based on advances in technology and operating practices.

2. Electrical System

- A. Modification to the existing vehicle wiring should be done only with extreme caution. The effects on the completed vehicle electrical system must be considered. Any additional circuitry should be evaluated to ensure that adequate circuit protection provisions will be in place and that feedback loops will not be created.
- B. The following affects the selection of wire gauge for a particular application:
- Wire size selection is affected by circuit protection requirements, power distribution requirements and mechanical handling requirements
 - Wire size selection is affected by long-range heat aging characteristics resulting from current loading
- C. Circuit Protection
- When adding loads to a base vehicle's protected circuit; be sure that the **total electrical load** through the base vehicle fuse or circuit breaker is less than the derated device rating. The total electrical load is the sum of the base vehicle circuit current requirement added to the add-on component(s) current requirements. Confirm the load with an ammeter.
- **DO NOT** increase the rating of a factory-installed fuse or circuit
 - Any added circuitry must be protected by either the base vehicle fuse or circuit breaker or by a similar device installed by the body builder. In-line fuses should be readily accessible
 - All battery circuits, except the starter motor, must have circuit protection
 - Protections devices for high current loads such as a winch or snowplow motor must be connected directly to the vehicle battery and not to the vehicle power distribution center or other downstream components.

Circuit protection devices are designed to protect the wiring. They may not necessarily

protect other components in the event of a short circuit.

3. Harness Routing

- A. Connectors should be readily accessible, where feasible, to permit ease of installation and serviceability. Accessibility to connectors is good design practice. Examples include fuse blocks, relays, modules, electrical components, junction blocks and ground blocks.
- B. Provide sufficient wire lengths to permit wire harness serviceability. However, excess lengths should be kept to a minimum to prevent: trapping and pinching during assembly; poor fit and finish; and buzzes, squeaks and rattles.
- C. Circuits attached to parts or structures that have dynamic (moving) properties must consider adequate "slack" and strain relief to prevent damage. A few examples are the engine block, door and liftgate harness, shocks, struts and tilt steering columns. Endurance testing must be performed to ensure that designs meet life test criteria.
- D. Wiring assemblies must not be within one inch (25 mm) of any hot surface or moving mechanism. Movement due to engine rocking will require a greater distance than one inch. Engineering discretion must be used to determine if heat-protection materials are needed to protect the wiring assembly. The use of abrasion-protection materials (convoluted tubing, fiberglass loom, asphalt loom, friction tape, etc.) can be used as an added measure in the protection of the harness, but should not be relied upon alone to prevent damage to the wiring assembly. Some examples of hot surfaces and moving mechanisms are:

- Plumbing
- Pulleys
- Catalytic converter
- Parking brake Mechanisms
- Floor pan
- Choke housing and crossover
- Hinges
- Belts
- Exhaust manifold
- Oil and fuel lines
- Accelerator, brake and clutch pedals
- Auxiliary oil cooler line
- Seat track and recliner mechanisms
- Window, door and door lock mechanisms

Wire routings should be away from areas where temperatures exceed 180°F and should have a minimum of six inches (152 mm) clearance from exhaust system components. If this is not possible, use heat shields and high-temperature insulation to maintain safe operating temperatures for the wiring.



WIRING CODE IDENTIFICATION INFORMATION

- Hole liner
 - Rolled sheet metal edge
 - Convolute, scroll, loom or braided sleeving
 - Edge protector (pinch welt)
 - Wiring clip
- A. Route wires on the surface of sheet metal to avoid “fishing” operations and to avoid sharp edges.
- B. Where wiring congestion or the possibility of pinching wires exists, the harness design should be a rigid shape and form. This will aid installation and facilitate fit and finish objectives. A good alternative design technique is the use of a stamped sheet metal or a molded plastic trough.
- C. Eliminate buzzes, squeaks and rattles (BSR) by the use of:
- Cloth tape
 - Direct connections to devices
 - Locating and/or clipping all connectors whether used or unused
 - Locating and/or clipping wire harnesses
 - Foam wrap, foam tubes, foam doughnuts on clips
- D. Route wiring away from areas where fasteners are driven.
- E. When a wire assembly is routed from the inside to the outside of the vehicle, the transition point must be sealed by:
- A rubber grommet
 - A rubber tube and grommet (highly recommended for doors and liftgates)
 - A sealed bulkhead-type connection
- F. Wires on the outside of the vehicle or in a wet environment should:
- Be routed lower than sealing devices to avoid water intrusion through the wire harness
 - Have a drip loop in the wiring harness to prevent water intrusion into the connector(s)
- G. High current circuits and pulse width modulation circuits should not be routed near the radio and other sensitive electronic devices. If rerouting is unavoidable grounded shielding or some other means of isolation may be required. If possible, high current circuits should be routed at least six inches away from the radio.
- H. Wire harnesses should not be routed closer than one inch (25 mm) from high voltage devices such as the distributor coil or spark plug wires.
- I. When underbody routing is unavoidable, provide a special wire jacket or covering, such as polyurethane, fiberglass sleeve or loom, for protection.
- J. Wire harnesses included with modular assemblies, such as headliners and door trim panels, must be routed and secured by utilizing clips, straps or adhesives to ensure proper retention and to prevent buzzes, squeaks or rattles.

4. Grounding

The following guideline outlines the general requirements for electrical system grounding to minimize ground loops, unwanted feedback, coupling of transients and electro-magnetic interference to ensure proper electrical and electronic system performance.

A. General Requirements

- 1) The battery negative terminal shall connect to the body and the engine with the shortest length cables as practical.
- 2) Each of the following types of ground circuits should connect to the body sheet metal as close as possible to the electrical/electronic device or combination of devices:
 - Electronic devices employing a single power ground for electronics and, where applicable, internal subminiature lamps
 - Inductive electrical devices and subsystems, such as motors, solenoids and relays (with noisy grounds) unless fully internally sup-pressed
 - The exception to this is high current loads such as a winch or snowplow motor which should be grounded directly to the vehicle battery to prevent overstressing the rest of the vehicle ground system
 - Lighting grounds — particularly where loop-type coupling into devices with internal lamps would be possible

B. Detailed Requirements

- 1) The battery to engine ground shall be sufficient to keep the total external cranking circuit resistance between the battery and starter terminals, including junctions, at two milliohms maximum. The battery ground from its terminal to body sheet metal shall not exceed two milliohms at 80°F.
- 2) Lighting grounds should not interconnect within wiring assemblies to electronic device and sub system grounds except at the attachment of the given wiring assembly to sheet metal.
- 3) Instrument panel subsystem grounds must have a dedicated ground for the A/C blower circuit. Door and seat actuator grounds are not to pass through the main instrument panel wiring assembly.

C. Grounding Connections

- 1) Steel ground screws shall have suitable cadmium, tin or zinc dichromate coating.
- 2) Metal surfaces for grounding shall be free of paint and other insulating coatings or will acquire this condition by using metal cutting fasteners.
- 3) Grounds to vehicle sheet metal shall employ one of the following fastening methods:
 - Weld stud and nut/washer assembly using a serrated eyelet
 - Weld or pierce nut and paint cutting screw



WIRING CODE IDENTIFICATION INFORMATION

- Externally serrated eyelet with pierced conical hole/depression and double threaded paint cutting screw that ensures high strip to drive torque ratio
- 1) The total resistance between ground terminations and ground surfaces should not exceed 0.05 milliohms
 - 2) No more than three wiring eyelet terminals shall be stacked together under a ground screw or on a stud
 - 3) Pop-riveted connections are not suitable for grounding wiring terminals

5. Sealing and Corrosion Protection

As a first choice, all connectors should be kept away from any splash or wet areas. When connectors are in a splash or wet area, added protection should be used to meet endurance requirements. Some examples of protection are sealed connectors, grease in connectors and barriers built to insulate the connector. Orient connectors "horizontally" to help minimize water penetration; avoid "vertical" connector orientations.

- **Greased and/or pre-greased terminals are not to be used on O2 sensor circuits.**
 - Grease in the connector or the terminals migrate through the wire strands and contaminate the sensor resulting in false readings
 - **Greased and/or pre-greased terminals are not to be used with hypalon insulation.**
 - It causes the insulation to swell and to deteriorate particularly in the presence of heat
 - Silicon grease is not to be used at all. It can migrate through wire strands and contaminate relay or switch contacts. It can also travel to the sheet metal destroying the adhesion of vehicle body paint
- 1) All metal sockets routed outside the vehicle must have watertight boots and grease or other means of corrosion protection.
 - 2) All lamp sockets in a wet area must be evaluated for sealing and corrosion protection.
 - 3) All grommets used in areas where moisture, water splash or exhaust fumes can enter into the passenger compartment must seal. Use applied grommets, sealed tube-and-grommet assemblies, sealed bulkhead connections, or molded grommets. Molded non-rubber grommets are less desirable.
 - 4) Unused wiring hole provisions that may allow moisture, fumes or noise to enter the passenger compartment must be plugged or sealed.
 - 5) Screws and clips located in a wet region must have a sealing provision.

- 6) Relays or circuit breakers should not be located in moisture splash area without adequate protection.
- 7) Wire harness routing from a wet to a dry environment must have drip loop construction. Locate the drip loop lower than the harness grommet; allow water runoff.

6. Harness Construction

- 1) All splices in moisture or splash areas should be sealed by molding or by sealed heat shrink tubing. See the Service Kit Part Numbers chapter of the Technical Information section of this Body Builder Guide for recommended heat shrink tubing available from Mopar. This heat shrink tubing has a built in sealing compound which flows upon heat application. This is also recommended for dry areas to increase reliability.
- 2) The following are general guidelines for splices:
 - Avoid imbalance of circuit size on each side of a splice.
 - Splices should be staggered by a minimum of 50 mm center-to-center to avoid electrical tracking and to minimize harness bulk.
 - Shielded cable should not be spliced.
 - When used in instrument panel wiring applications, PVC tape may squeak when in contact with some panel plastics. Use foam or cloth tape harness wrap to prevent potential BSR conditions.
- 3) The following are general guidelines for harness components:
 - Use insulators having secondary terminal latching (example: wedge-lock) and connector-to-connector latching (example: locking type) whenever possible. Connector-to- device, such as switches, relays, motors, radios, speakers and modules, should have a positive latching design
 - Wire color matching and insulator color matching is **NOT** a reliable means of insulator polarization. Indexing mating connections and/or keeping similar colored insulators sufficiently separated to prevent misassembly are recommended practices
 - Connectors that provide the best terminal protection against inadvertent shorting in a nonmated connector should be on the vehicle side of the wiring assembly. This is usually the female terminal
 - All 10 AWG wires or larger must be soldered to the terminals
 - Do not use spin-on wire nuts
 - Make sure that an adequate mechanical joint exists before soldering. Use only rosin core **Solder**



WIRING CODE IDENTIFICATION INFORMATION

7. Electromagnetic Capability (EMC)

- Any electrical/electronic (E/E) device, module, subsystem or system used on Chrysler Group LLC vehicles shall meet Chrysler Group LLC Performance Standards PF-10614 entitled Electromagnetic Compatibility Specifications for Electrical and Electronic Modules and Motors and PF-10615 Electrical Specifications for Electrical and Electronic Modules and Motors. The relevant tests are performed in accordance with DCA LP-388-C, and Chrysler Group LLC determines pass-fail limits
- Vehicles being produced in or for the Canadian market must meet Canadian regulation ICES 002 Issue 2.
- Vehicles being produced for European Union countries must meet EEC 72/245/EEC as amended by 95/54/EC dated 10/31/95. Other European countries must meet broadband RF Emission regulation ECE Regulation 10.02 2002-02
- Major vehicle metallic components need to be electrically bonded together to provide for RF shielding and maintain good electrical ground integrity. The DC resistance between the engine, hood, doors, and other major vehicle body panels to body ground should not exceed 250 milliohms (ref: DS-108)
- Body panels around the engine compartment or ignition system must not be changed without verifying that the vehicle still meets the appropriate Canadian and/or European RF Emissions regulations. If vehicle body panels around the engine compartment are replaced by nonmetallic panels, they may need to incorporate metallic material to reduce the amount of RF that will be emitted from the vehicle so it will meet the appropriate standards
- Care must be exercised in installing two-way communication radio transmitters in vehicles so they do not cause degradation of preference/operation of the vehicle. Two-way radio installation guidance is provided by Chrysler Group LLC Technical Service Bulletin TSB 08-023-99
- Electrical circuits added to the vehicle shall be designed with separate power leads protected by appropriately sized wiring, fuse links, circuit breakers and/or fuses
- Conductive fuel tank filler necks and trapdoor assemblies must be connected to the vehicle ground system with less than 100ohms resistance to insure discharge before fueling. If this path is modified, compliance to this requirement must be maintained and verified.
- Non-conductive fuel tank filler necks and trapdoor assemblies must be connected to the

vehicle ground system with less than 1,000,000 ohms (1Mohm) resistance (using a 500V source) to insure discharge before fueling. If this path is modified, compliance to this requirement must be maintained and verified.

8. Current Capacity of Wire

The following table shows the maximum rated current capacity of plastic insulated copper wire. Temperature affects current capacity of a given wire and the type of insulation. This table shows generally accepted values.

Wire Gauge	Maximum Current Capacity
10	45 Amperes
12	30 Amperes
14	25 Amperes
16	20 Amperes
18	15 Amperes
20	10 Amperes

- Extending a circuit by splicing — use a wire gauge equal to or greater than the wire in the circuit to be lengthened after the splice
- Adding devices from a base vehicle circuit — use the above table to determine the wire gauge for the required current capacity
- Added wiring should have Hypalon, cross-linked polyethylene insulation or a similar type of thermosetting insulation

9. Referenced Publications

The following documents are recommended for further information.

ANSI Publication. American National Standards Institute, 11 West 42nd Street, 13th Floor, New York, NY 10036

ANSI/RVIA 12V Low Voltage Systems in Conversion Vehicles
ANSI A119.2 – 1995, Standard for Recreational Vehicles

SAE Publication. Society of Automotive Engineers, Inc., 400 Commonwealth Drive, Warrendale, PA 15096

SAE J554 – 1987, Standard for Electric Fuses (Cartridge Type)

SAE J551-4 – 1994, Test Limits and Methods of Measurement of Radio Disturbance Characteristics of Vehicles and Devices, Broadband and Narrowband, 150 kHz to 1000 MHz



WIRING CODE IDENTIFICATION INFORMATION

SAE J561 – 1993, Electrical Terminals – Eyelet and Spade Types

SAE J2223/3 – 1994, Electrical Terminals – Blade Type

SAE J928 – 1989, Electrical Terminals – Pin and Receptacle Type

SAE J1284 – 1988, Electrical Terminals – Standard for Blade-Type Electric Fuses

SAE J2077 – 1990, Miniature Blade-Type Electric Fuses

SAE J1888 – 1990, High Current Time Lag Electric Fuses

SAE J1292 – 1981, Automobile, Truck, Truck Tractor, Trailer, and Motor Coach Wiring

SAE J562 – 1986, Nonmetallic Loom

SAE J573 – 1989, Miniature Lamp Bulbs

SAE FMEA plus For Windows, Failure Modes and Effects Analysis Software

Chrysler Group LLC

PF 10614 Performance Standard – Electromagnetic Compatibility Specification for Electrical and Electronic Modules and Motors

PF 10615 Performance Standard – Electrical Specifications for Electrical and Electronic Modules and Motors

Technical Service Bulletin 08-023-99: Installation of Radio Transmitting Equipment

Lab Procedure – LP 388-C-xy: Electrical and EMC























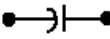













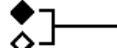
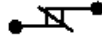

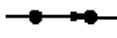





DS-108 – Grounding Guidelines

Additional Referenced Documents

*Industry Canada ICES-002 Issue 2
European Union 72/245/EEC as amended by
95/54/EC dated 10/31/95
ECE Regulation 10.02 2002 - 02*



WIRING CODE IDENTIFICATION INFORMATION

LEGEND OF SYMBOLS USED ON WIRING DIAGRAMS			
	POSITIVE		BIDIRECTIONAL ZENER DIODE
	NEGATIVE		MOTOR
	GROUND		ARMATURE AND BRUSHES
	FUSE		CONNECTOR IDENTIFICATION
	GANG FUSES WITH BUSS BAR		MALE CONNECTOR
	CIRCUIT BREAKER		FEMALE CONNECTOR
	CAPACITOR		DENOTES WIRE CONTINUES ELSEWHERE
	OHMS		DENOTES WIRE GOES TO ONE OF TWO CIRCUITS
	RESISTOR		SPLICE
	VARIABLE RESISTOR		SPLICE IDENTIFICATION
	SERIES RESISTOR		THERMAL ELEMENT
	COIL		TIMER
	STEP UP COIL		MULTIPLE CONNECTOR
	OPEN CONTACT		OPTIONAL WIRING WITH WIRING WITHOUT
	CLOSED CONTACT		"Y" WINDINGS
	CLOSED SWITCH		DIGITAL READOUT
	OPEN SWITCH (SPST)		SINGLE FILAMENT LAMP
	CLOSED GANGED CONTACT		DUAL FILAMENT LAMP
	OPEN GANGED SWITCH (DPST)		LED — LIGHT EMITTING DIODE
	SINGLE POLE DOUBLE THROW SWITCH (SPDT)		THERMISTOR
	PRESSURE SWITCH		GAUGE
	SOLENOID SWITCH		SENSOR
	MERCURY SWITCH		FUEL INJECTOR
	DIODE OR RECTIFIER		

